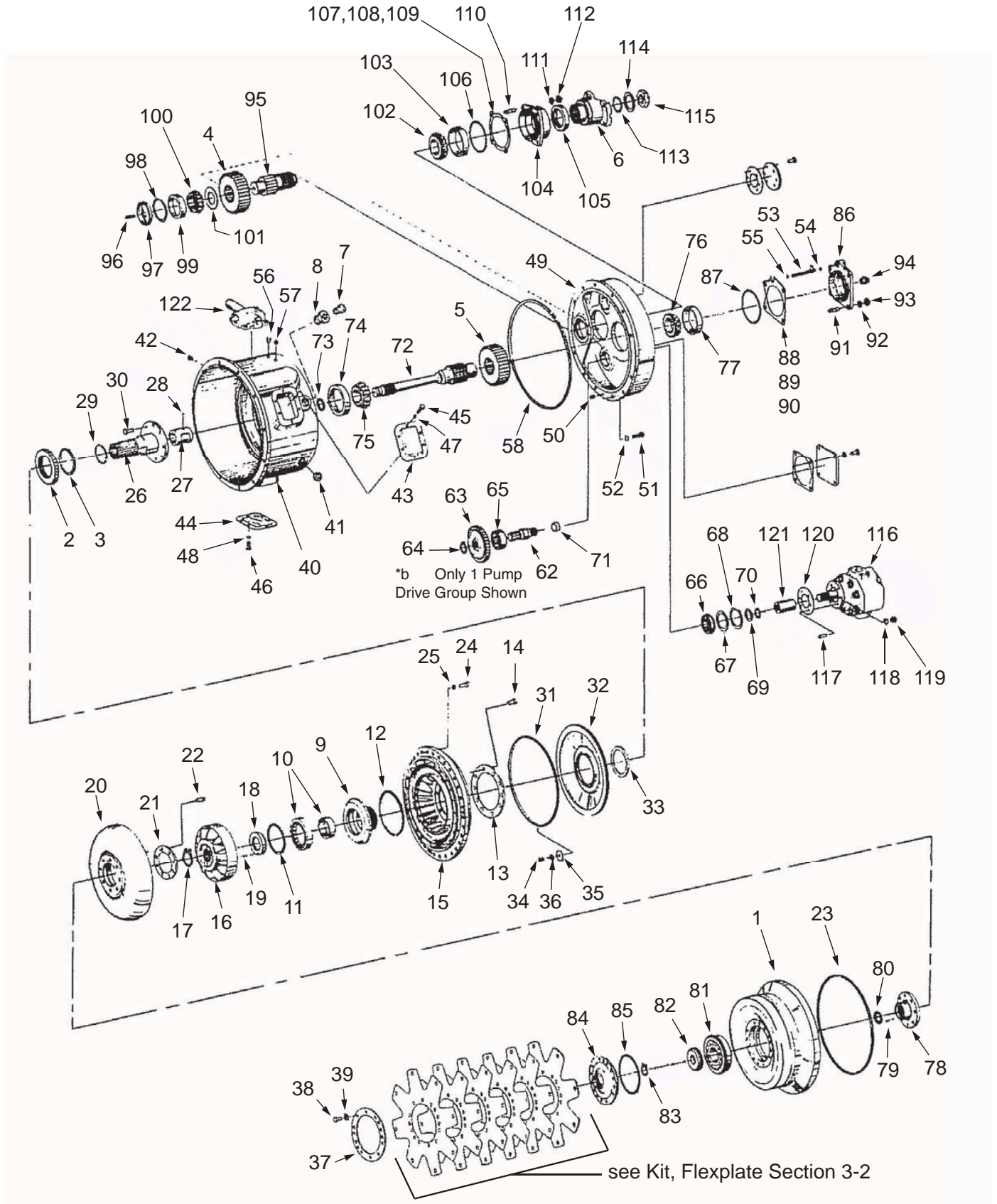

Converter

Converter

Item	Part No.	Qty	Description	Item	Part No.	Qty	Description
	256295		Converter				
1	257362	1	. Cover, Impeller 16.0	62	*b 234901	3	. Shaft, Pump Drive
2	234904	1	. Gear, Impeller Hub	63	*b 234902	3	. Gear, Pump Drive
3	*c 212472	1	. Ring, Snap	64	*b*c 234564	3	. Ring, Snap
4	212447	1	. Gear	65	*b*c 212489	3	. Bearing
5	212447	1	. Gear, Turbine Shaft	66	*b*c 212491	3	. Bearing
6	212252	1	. Flange, Output	67	*b*c 212500	3	. Washer
7	*c R233598	1	. Breather, 1-Way	68	*b*c 212493	3	. Ring, Snap
8	209510	1	. Fitting	69	*b*c 212499	3	. Shim
9	236078	1	. Hub, Impeller	70	*b*c R224039	3	. Shim
10	*c 212506	1	. Bearing	71	*b 234903	3	. Spacer
11	*c 212527	1	. Ring, Snap	72	222445	1	. Shaft
12	*c 87287W	1	. O-Ring	73	*c 242390	1	. Ring, Seal
13	*c 236079	1	. Backup Ring	74	*c 212470	1	. Bearing Cup
14	*c 233079	16	. Capscrew	75	*c 212469	1	. Bearing Cone
15	235675	1	. Impeller	76	*c 212434	1	. Bearing Cone
16	212525	1	. Reaction Member	77	*c 203110	1	. Bearing Cup
17	*c 212283	1	. Ring, Snap	78	212524	1	. Hub
18	212507	1	. Spacer	79	*c 212523	2	. Dowel
19	*c 212526	1	. Pin, Roll	80	*c 212511	1	. Ring, Snap
20	212510	1	. Turbine	81	*c 212521	1	. Bearing
21	*c 233084	1	. Backup Ring	82	240541	1	. Retainer, Bearing
22	*c 257361	8	. Screw	83	*c 212514	1	. Ring, Snap
23	*c 214760	1	. O-Ring	84	257363	1	. Cap, Brg
24	18558W	32	. Capscrew	85	*c 212515	1	. O-Ring
25	200603	32	. Washer, Lock	86	212455	1	. Cap
26	212474	1	. Sleeve Assembly, Stator Support	87	*c 236882	1	. O-Ring
27	*c 212475	1	. Sleeve	88	*c 212482	AR	. Shim
28	212358	1	. Ball, Steel	89	*c 212483	AR	. Shim
29	*c 242393	1	. Ring, Seal	90	*c 212484	AR	. Shim
30	237295	8	. Capscrew	91	241146	4	. Stud
31	*c R4095394	1	. O-Ring	92	200604	4	. Washer, Lock
32	212502	1	. Baffle, Oil	93	205124	4	. Nut
33	*c 222453	1	. Seal, Oil	94	209916	1	. Fitting
34	16597W	3	. Capscrew	95	212446	1	. Shaft, Converter Output
35	212531	3	. Washer	96	212451	1	. Tube
36	217798	3	. Washer, Lock	97	*c 212431	1	. Baffle
37	256300	1	. Plate, Backing Flex Plate	98	*c 212450	1	. Ring, Snap
38	223089	14	. Capscrew	99	*c 212432	1	. Bearing Cup
39	200603	14	. Washer, Lock	100	*c 230405W	1	. Bearing Cone
40	257359	1	. Housing, Converter	101	*c 212433	1	. Spacer
41	233087	4	. Plug, Drain	102	*c 212434	1	. Bearing Cone
42	209511	1	. Plug	103	*c 203110	1	. Bearing Cup
43	212477	1	. Plate, Cover	104	212442	1	. Bearing Cap & Seal
44	212477	2	. Plate, Cover	105	*c 212250	1	. Seal
45	18535W	2	. Capscrew	106	*c 236877	1	. O-Ring
46	18535W	4	. Capscrew	107	*c 212443	AR	. Shim
47	201567	2	. Washer, Lock	108	*c 212444	AR	. Shim
48	201567	4	. Washer, Lock	109	*c 212445	AR	. Shim
49	257360	1	. Cover, Rear	110	241146	4	. Stud
50	212486	1	. Pin, Dowel	111	200604	4	. Washer, Lock
51	214234	12	. Capscrew	112	205124	4	. Nut
52	200603	12	. Washer, Lock	113	*c 236880	1	. O-Ring
53	212457	1	. Tube	114	*c 212254	1	. Washer, Flange
54	*c R13805270	1	. O-Ring	115	218486	1	. Nut, Lock
55	*c R13805270	1	. O-Ring	116	222452	1	. Pump, Converter
56	209512	1	. Fitting	117	233078	6	. Stud
57	209512	1	. Fitting	118	201567	6	. Washer, Lock
58	*c 258918	1	. O-Ring	119	R13803692	6	. Nut, Hex
59	*a 245442	2	. Bushing, Speed Sensor Adj	120	*c R235961	1	. Gasket
60	*a 245075	2	. Plug, Screw	121	228684	1	. Sleeve, Pump (see page 5)
61	*a*c 250784	2	. O-Ring	122	247461	1	. Valve, Regulating (see page 4)

AR As Required
 *a Not Illustrated
 *b Only 1 Pump Drive Group Shown
 *c Included in Kit, Service: 596933

Converter



Valve, Regulating

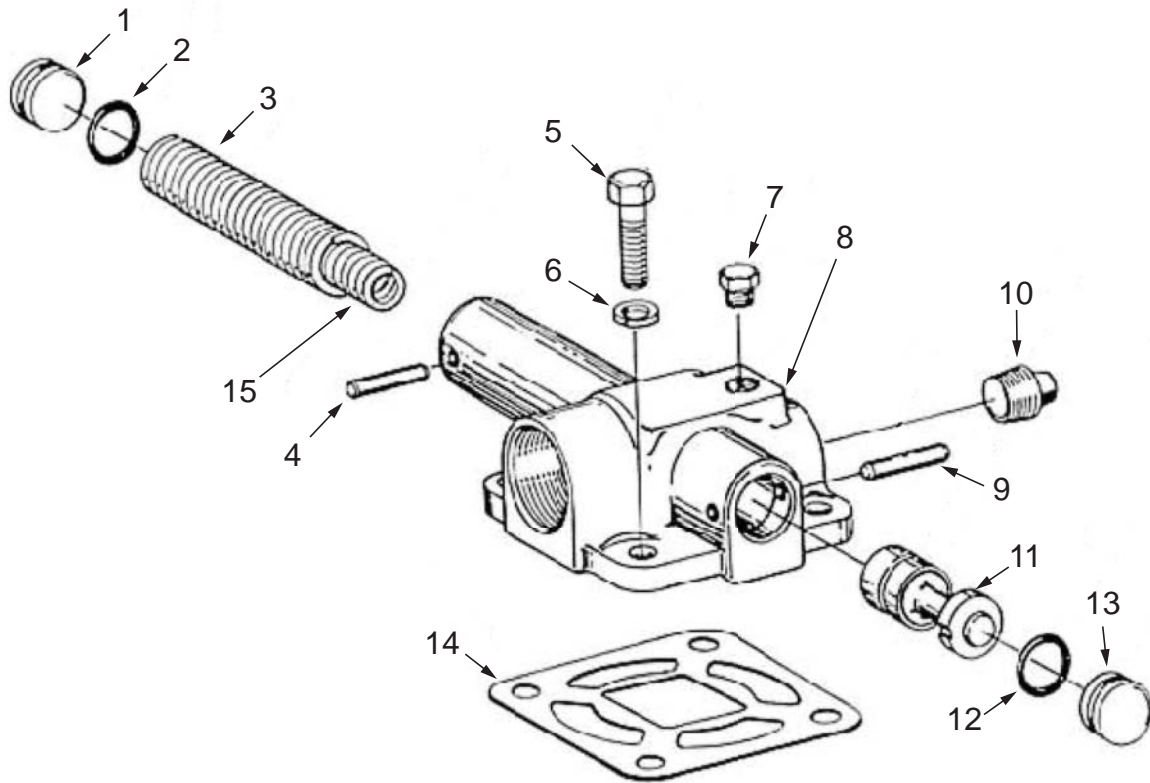

Item	Part No.	Qty	Description	Item	Part No.	Qty	Description
	247461		Valve, Regulating				
1	212546	1	. Stop, Piston	9	212548	1	. Pin, Roll
2	*c 257364	1	. O-Ring	10	216672	1	. Plug, Pipe
3	*c 212547	1	. Spring	11	212551	1	. Piston, Valve
4	212548	1	. Pin, Roll	12	*c 257364	1	. O-Ring
5	223089	4	. Capscrew	13	212546	1	. Stop, Piston
6	200603	4	. Washer, Lock	14	*c 212552	1	. Gasket
7	209512	1	. Fitting	15	*c 212553	1	. Spring
8	233089	1	. Valve Body				

*c Included in Kit, Service: 596933

Sleeve, Pump

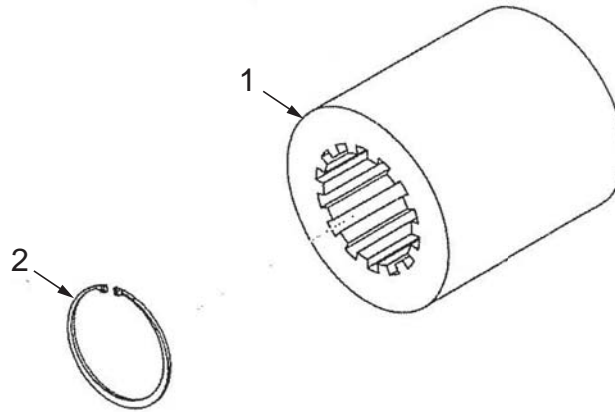

Item	Part No.	Qty	Description	Item	Part No.	Qty	Description
	228684		Sleeve, Pump Assembly				
1	213311	1	. Sleeve, Pump				
2	*c 212395	1	. Ring, Snap				

*c Included in Kit, Service: 596933