

Doors, Cab

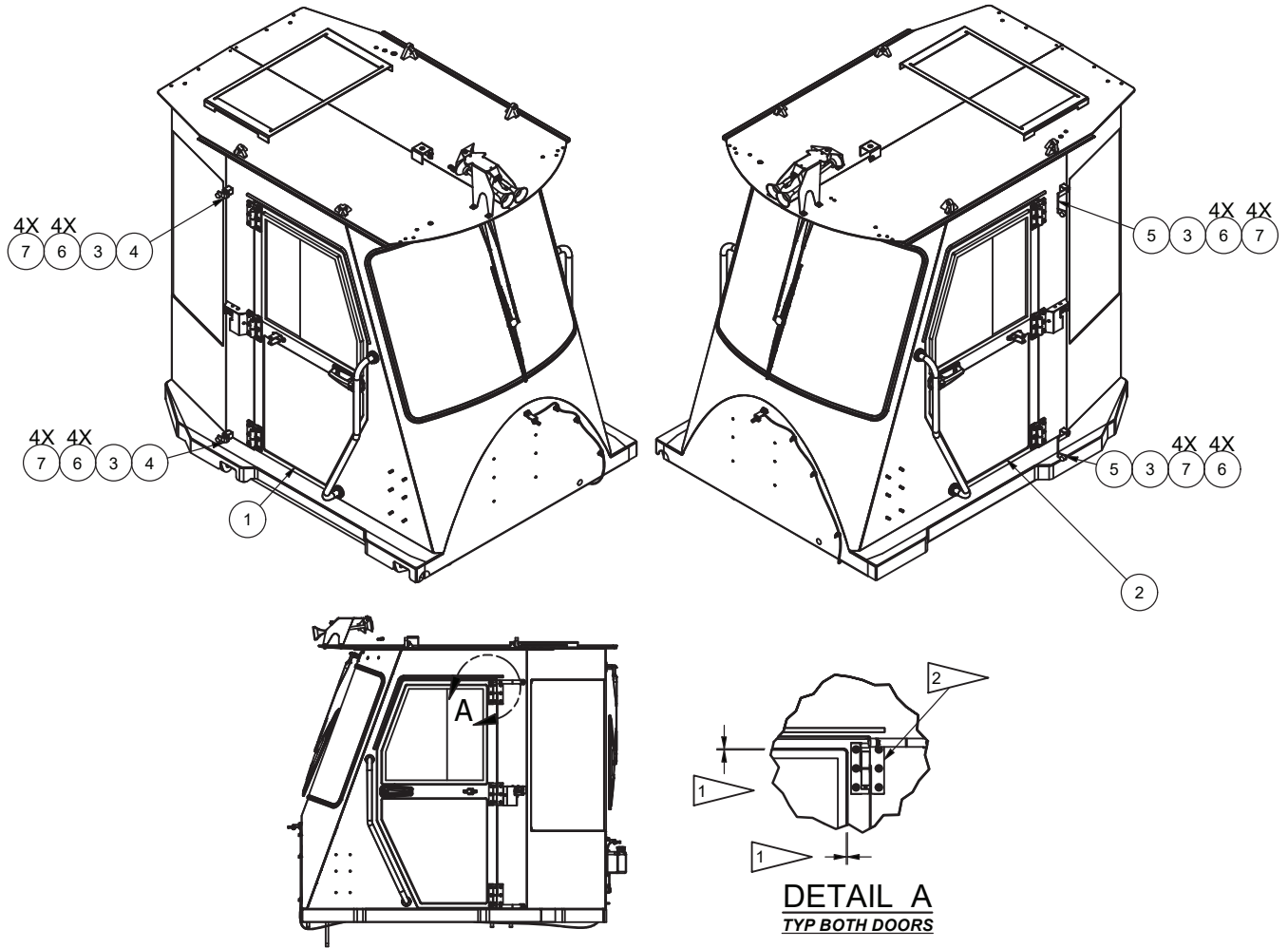

1 DOOR CLEARANCE SHOULD BE UNIFORM ALL THE WAY AROUND.
CLEARANCE IS 0.13" ± 0.03"

2 HARDWARE AND ATTACHING COMPONENTS ARE CALLED OUT WITH THE CAB
COMMON PARTS

Item	Part No.	Qty	Description	Item	Part No.	Qty	Description
	594707		Doors, Cab	5	590010	2	. Door Spring Assembly
1	* 596348	1	. Assembly, Door - RH	6	18460W	8	. Capscrew
2	* 596351	1	. Assembly, Door - LH	7	221763W	8	. Washer
3	590052	4	. Stop, Door				
4	590010	2	. Door Spring Assembly				* See Separate Coverage