

Valve, Control

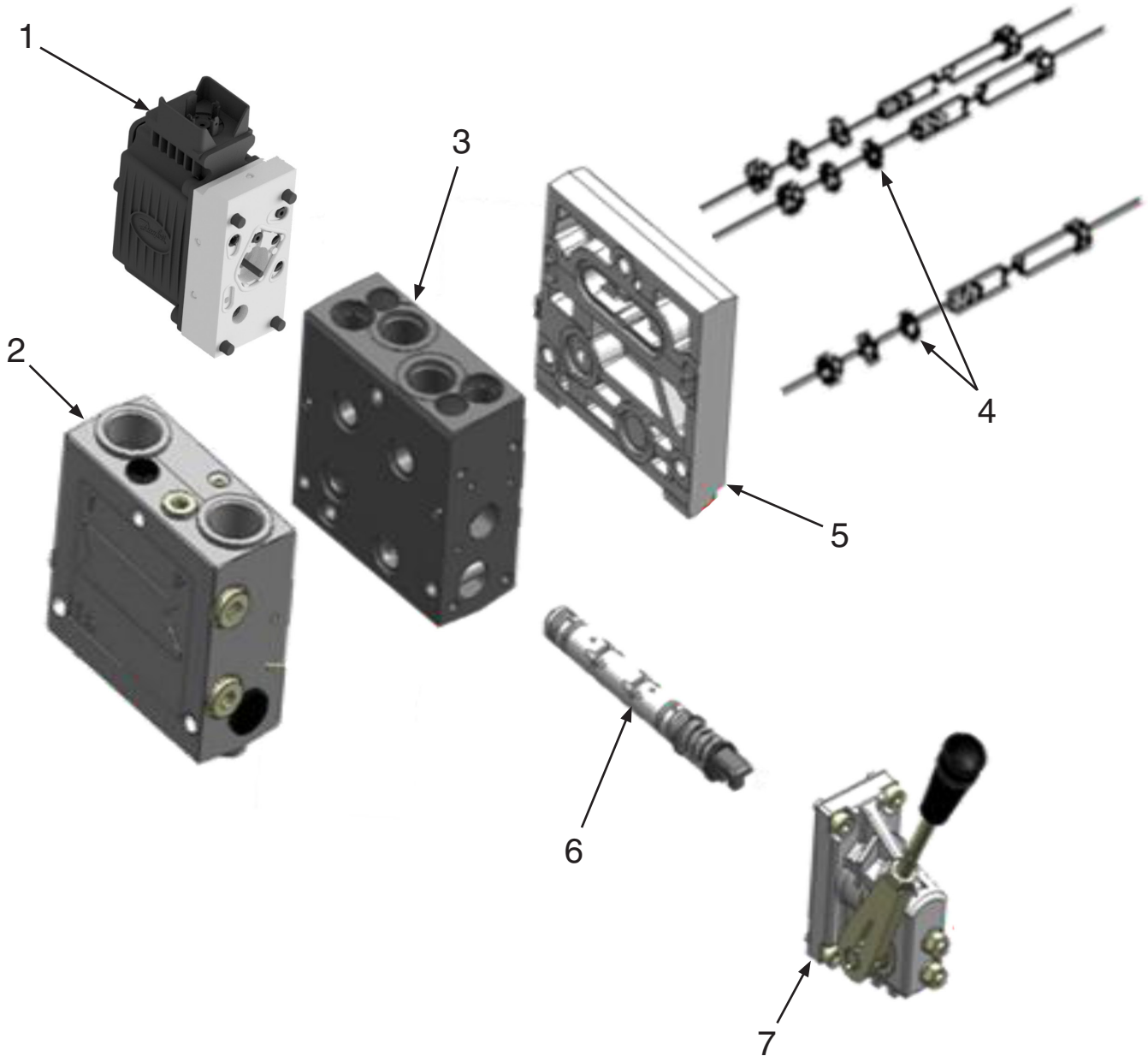

Item	Part No.	Qty	Description	Item	Part No.	Qty	Description
	593879		Valve, Control				
1	240652	1	. Actuator, Electronic	5	244954	1	. Cover Plate
2	233192	1	. Inlet	6	593877	1	. Spool
3	243420	1	. Work Section	7	243085	1	. Handle Assembly
4	244955	1	. Kit, Bolt & Seal				