

Air Conditioner/Heater Installation

Air Conditioner/Heater Installation

Item	Part No.	Qty	Description	Item	Part No.	Qty	Description
	593735		Air Cond/Heater Installation				
1	* 590805	1	. Pressurizer	63	R740866	7	. Pin, Male
2	590661	1	. Plate, Mounting	64	R740867	7	. Seal, Wire
3	* 258674	1	. Condenser, Remote	66	R13809366	5	. Capscrew
4	* 258675	1	. Air Cond/Heater	69	586847	4	. Plate, Stiff
7	258671	1	. Fitting	72	*a 590868	1	. Line Set Installation, A/C
8	258672	1	. Fitting	73	Y17C-0616	4	. Capscrew
9	245394	1	. Elbow, Rubber	74	Y25G-0608	6	. Capscrew
10	258705	4	. Louver	75	588177	1	. Plate, Mounting
15	258715	67IN	. Duct, Fiber	76	588178	1	. Plate, Mounting
17	258717	2	. Elbow	77	588175	1	. Cover Plate
18	258718	2	. End Cap	78	241059	4	. Insert
19	258719	12	. Rivet, Snap	79	* 589053	1	. Fan , Defrost
20	252077	1	. Fitting	80	00109451	3	. Machine Screw
21	259104	1	. Fitting	81	00190637	3	. Nut
27	209588	1	. Clip	82	223774	2	. Connector, Cord
28	R13810035	11	. Clamp	83	220582	2	. Ring Nut
30	586628	1	. Cover,Duct	84	R10817	4LB	. Refrigerant
31	586629	2	. Cover,Duct	85	na	0	. Ball Valve
33	R13809945	2	. T-Bolt Clamp	86	na	0	. Hose End
34	586768	1	. Bracket, Heater Valve	87	na	0	. Bracket Weldment, Mounting
35	586769	1	. Plate,Mounting	88	* 590074	1	. Air Cond/Heater
37	586771	1	. Coupling Weldment	89	na	0	. Fitting
40	589079	1	. Gasket	90	R13810992	5	. Capscrew
41	221499W	4	. Capscrew	91	243348	5OZ	. Oil, Refrigerant
42	221763W	14	. Washer	92	296418W	5	. Hard Washer
43	221767W	12	. Hard Washer	93	591318	4	. Washer
44	223759	1	. Connector, Cord	94	208264	1	. Grommet
45	224120W	4	. Capscrew	95	586853	1	. Bracket, Sensor
46	R13811190	21	. Locknut	96	238000	1	. Hose, Elbow
48	238160	2	. Connector, Wire	97	517462	1	. Coupling
49	239025	2	. Fitting	99	*a 593736	1	. Kit, Hose
50	245498	2	. Tee, Nylon	99.1	245275	12FT	. . Hose Assembly
52	254487	2	. Elbow	99.2	590745	1	. . Hose Assembly
53	256667	10'	. Cord	99.3	590746	1	. . Hose Assembly
57	R13802914	33	. Hard Washer	99.4	593737	1	. . Hose Assembly
58	201431	14	. Hose Clamp	99.5	259356	1	. . Hose Assembly
60	R13811014	12	. Capscrew	99.6	na	19 FT	. . Hose Assembly
61	R13811189	5	. Locknut	99.7	245663	6FT	. . Hose Assembly
62	R13811191	4	. Locknut	99.8	593738	1	. . Hose Assembly

* See Separate Coverage
 *a Item Not Illustrated
 na Not Applicable

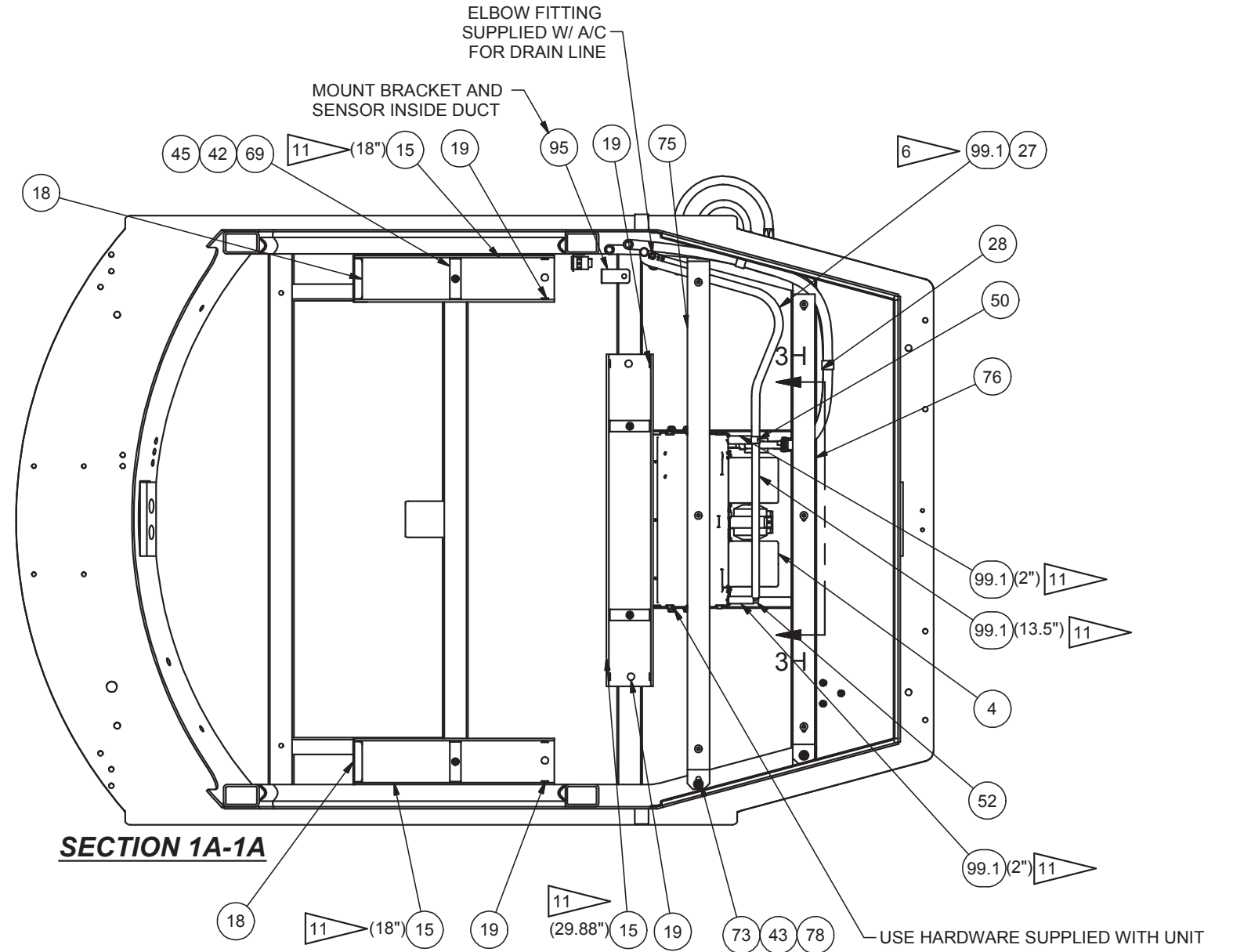
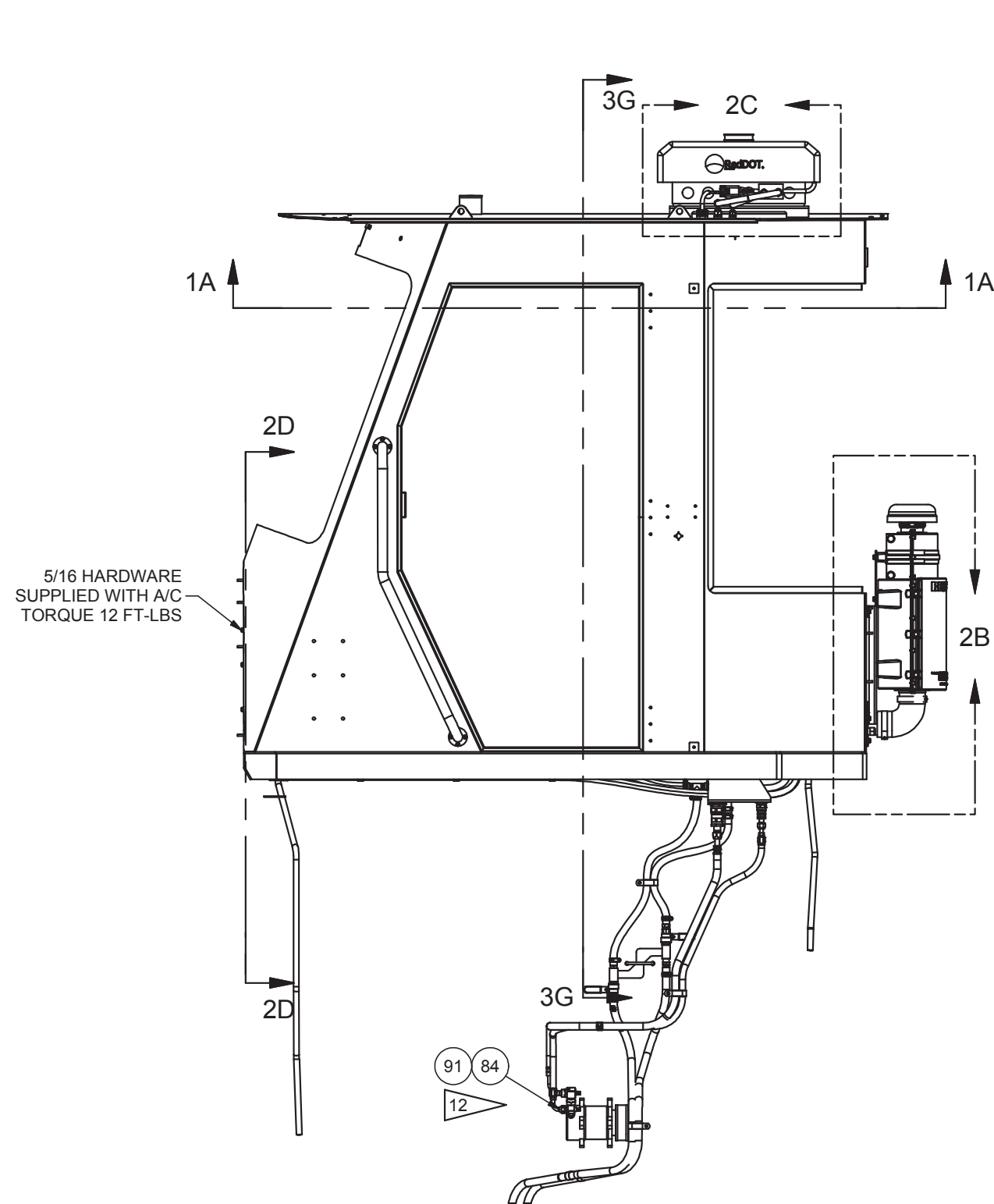

- NOTES:
- 1: COMPONENTS ARE PART OF TEMPERATURE CONTROL - 589698; SEE OVERHEAD CONSOLE ASS'Y
 - 5: SECURE HEATER HOSE AND A/C HOSES TO SUPERSTRUCTURE AND CHASSIS
 - 6: INSTALL CONDENSATE DRAIN LINE IN A CONTINUOUS DOWNWARD DIRECTION
 - 9: ATTACH DEFROSTER HOSE FROM A/C-HEATER TO LOUVERS IN FRONT PANELS
 - 11: APPROXIMATE LENGTHS ARE SHOWN IN () NEXT TO BUBBLE NUMBER, (PH) STANDS FOR PLACE HOLDER
 - 12: SEE POWER UNIT FOR COMPRESSOR INSTALLATION INFORMATION

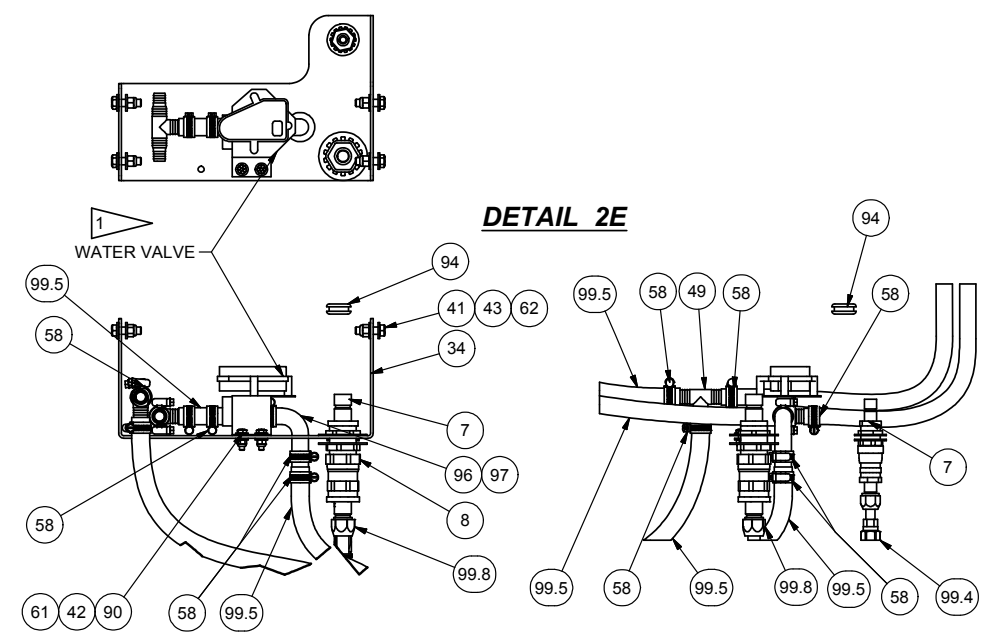
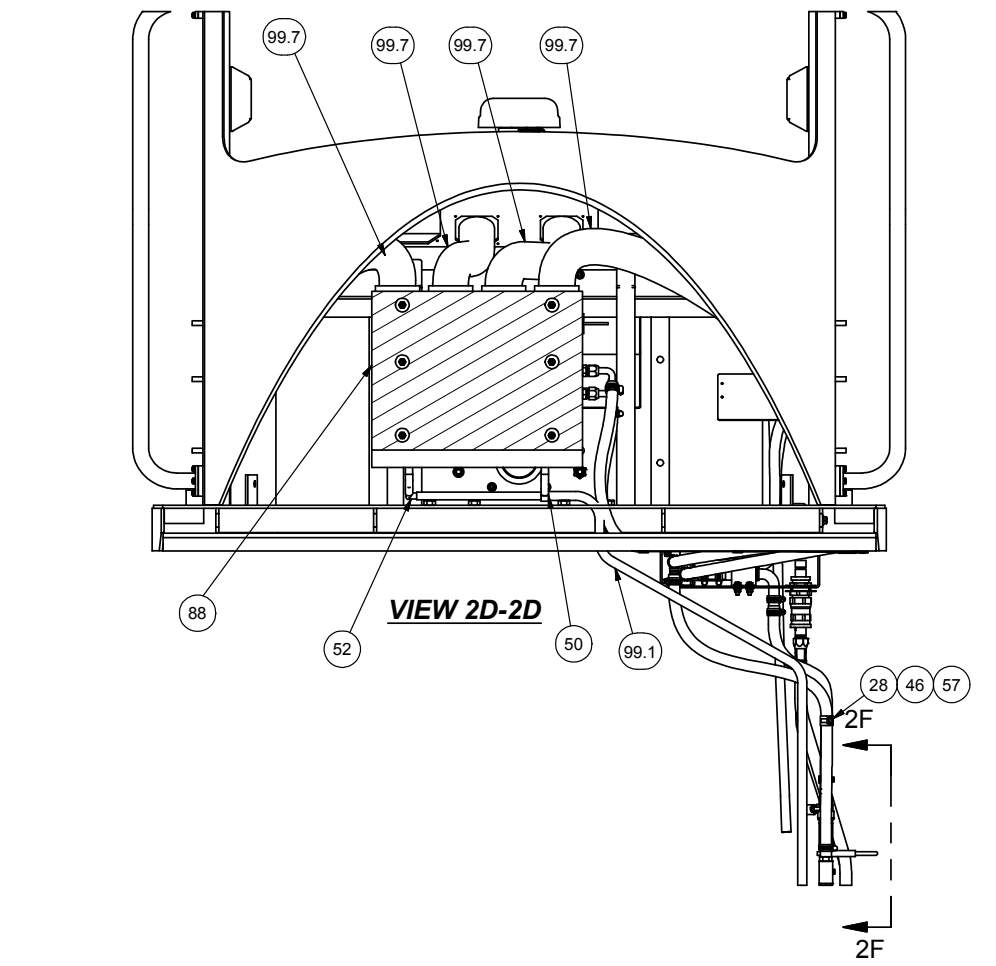
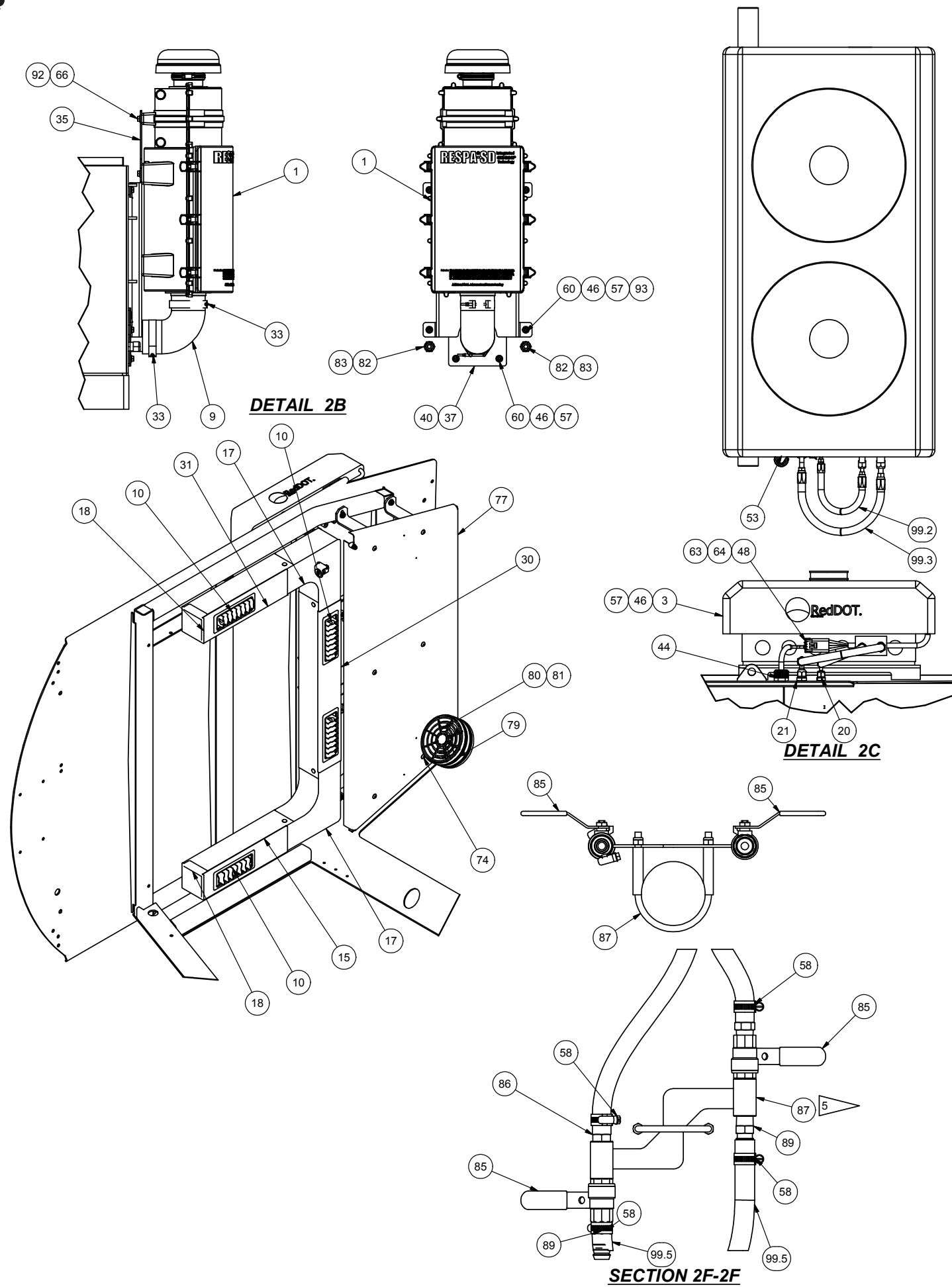

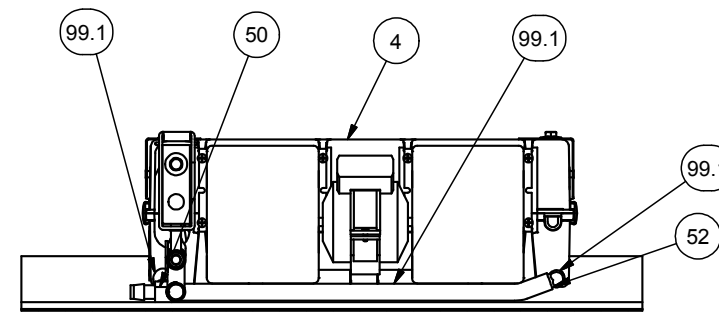

SECTION 3H-3H

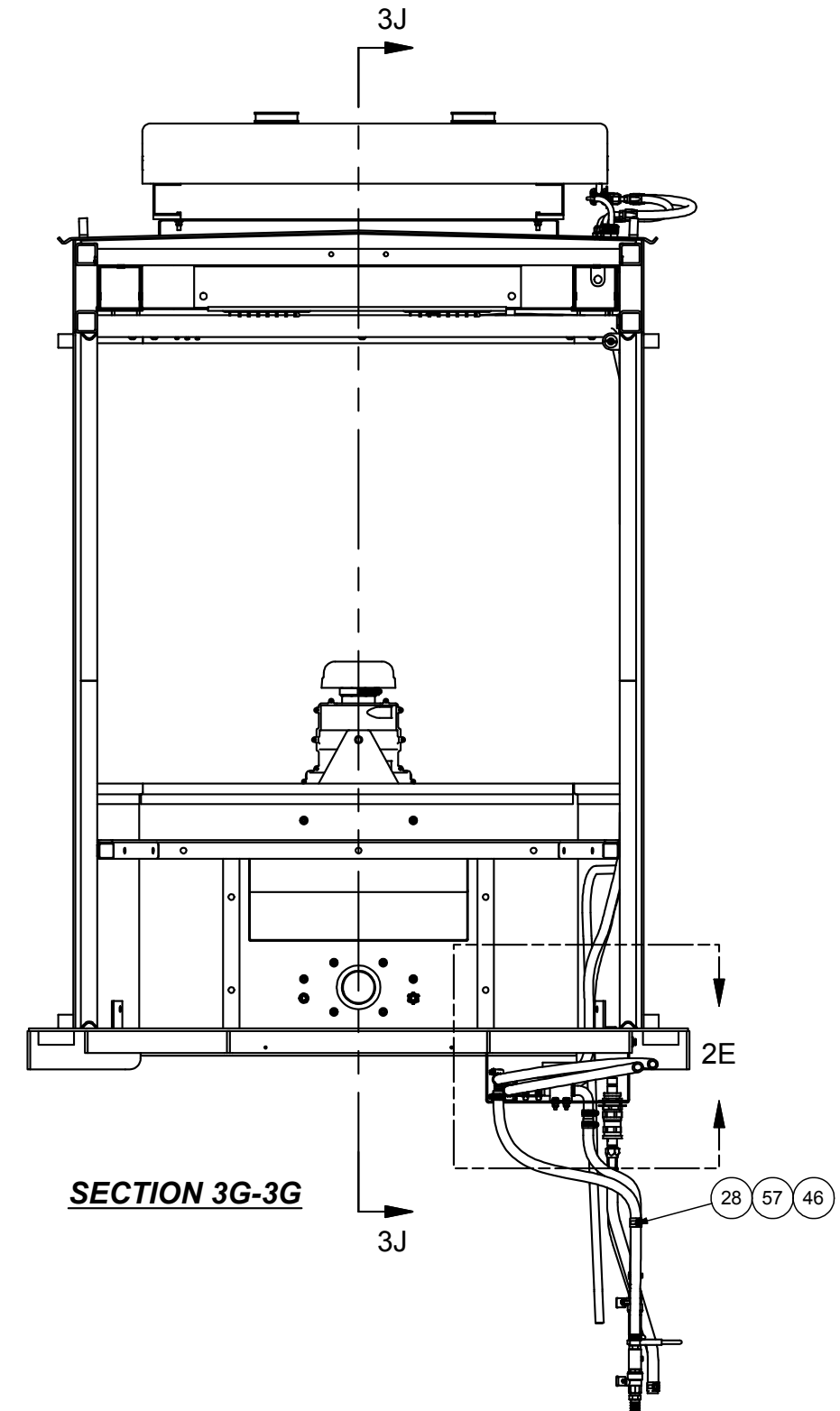

SECTION 3G-3G

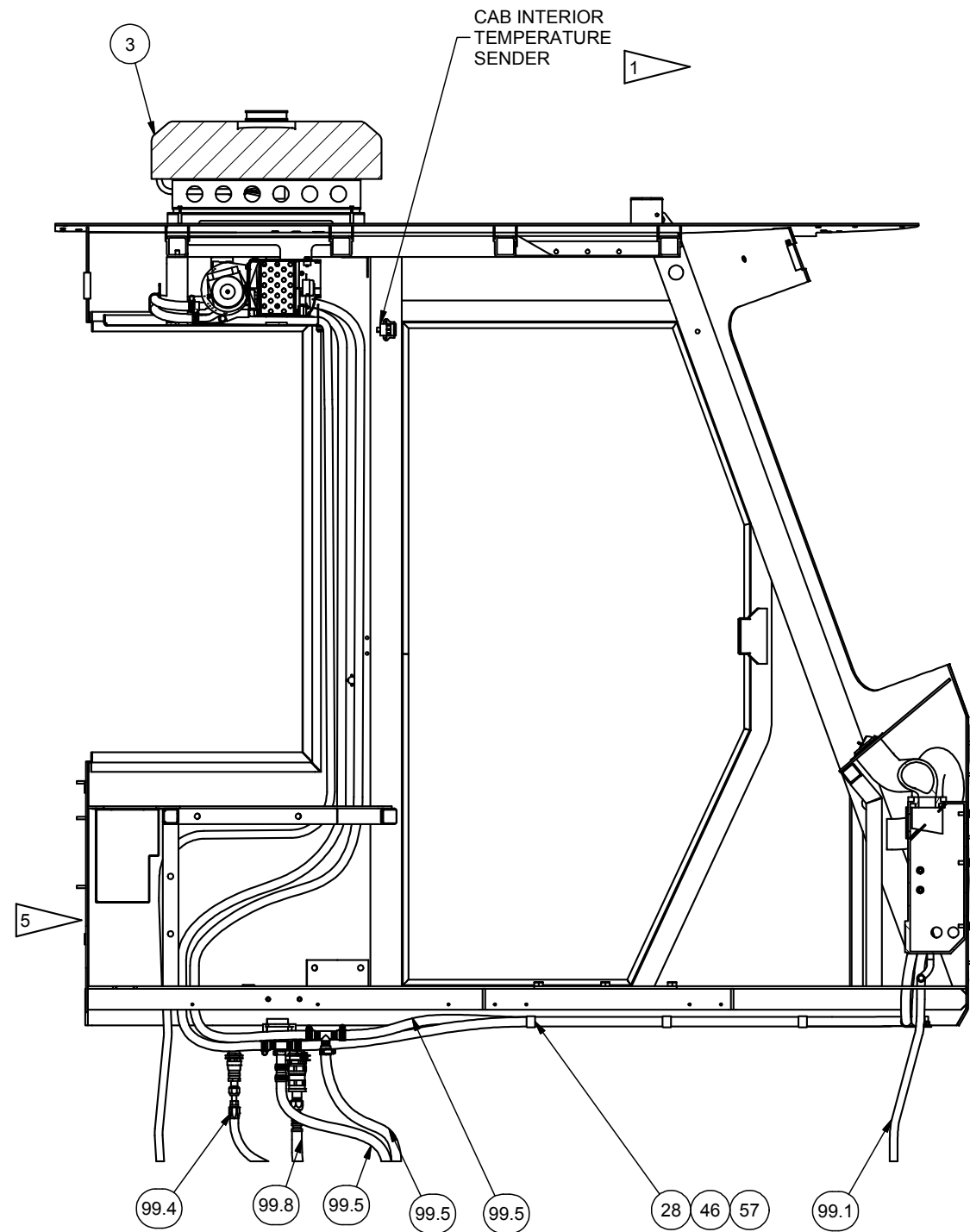

SECTION 3J-3J

FROM COMPRESSOR
TO CONDENSER

FROM EVAPORATORS
TO COMPRESSOR

CAB INTERIOR
TEMPERATURE
SENDER