

Seat Installation W/Rotation

Seat Installation W/Rotation

Item	Part No.	Qty	Description	Item	Part No.	Qty	Description
591307				Seat Installation, W/ Rotation			
1	* 591635	1	. Platform Assembly	25	240566	2	. Relay
2	579412	1	. Angle	26	*a 240519	1	. Thermistor
3	00103339	6	. Flat Washer	27	574208	1	. Bracket
5	221767W	6	. Hard Washer	28	* 574276	1	. Actuator
7	221771W	6	. Washer	29	574409	1	. Plate, Mounting
8	R13811191	2	. Locknut	30	586804	1	. Bulkhead
9	*b Y25G-0408	6	. Capscrew	31	219436	10'	. Wire
10	*c Y17C-0616	6	. Capscrew	32	231707	2'	. Wire
11	*c Y17C-0624	1	. Capscrew	33	588904	1	. Shim
12	*c R13801813	2	. Capscrew	34	589094	2	. Shim
13	*c R13811043	1	. Capscrew	35	230838	2	. Connector, Cord
14	*d 200454W	6	. Capscrew	36	230764	2	. Ring Nut
15	200247	4	. Terminal Ring	37	237058	1	. Fitting
16	228351	10	. Terminal Ring	38	591654	1LB	. Grease
17	221179	2	. Terminal Ring	39	R1933720	2	. Plug
18	22635	2	. Diode	40	587019	13FT	. Loom, Wire
19	243304	2	. Bearing Cup				
20	243305	2	. Bearing Cone				
21	240151	2	. O-Ring				
22	576444	1	. Tube				
23	576445	1	. Retainer, Bearing				
24	*b Y95G-0820	6	. Capscrew				
							* See separate coverage
							*a Not Illustrated - Mounted on circuit breaker panel.
							*b Torque 86-90 IN-LBS.
							*c Torque 27-29 FT-LBS.
							*d Torque 64-67 FT-LBS.

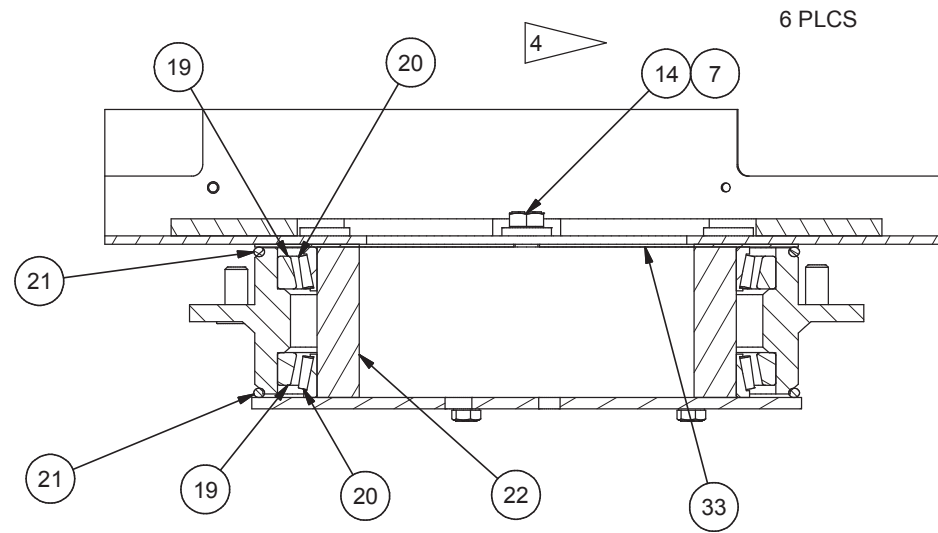

SECTION C-C

- NOTES:**
- 1 LOCATE THERMISTOR ON CIRCUIT BREAKER PANEL NEXT TO SEAT ROTATE CIRCUIT BREAKER.
 - 2 TORQUE 86-90 IN-LBS.
 - 3 TORQUE 27-29 FT-LBS.
 - 4 TORQUE 64-67 FT-LBS.
 - 5 L60 SWIVEL MOTOR MOUNTS TOWARDS FRONT OF CAB.
 - 6 LUBRICATE WITH ITEM 38. GREASE UNTIL GREASE IS VISABLE AT THE O-RING SEAL.
1. WIPE OFF RESIDUAL GREASE
2. ROTATE THE SEAT PLATFORM 90° AND REPEAT.
3. ROTATE THE SEAT PLATFORM SEVERAL TIMES AND WIPE AWAY ANY RESIDUAL GREASE THAT ACCUMULATES ON THE O-RING SEAL.
 - 7 INSTALL PLUG IN FLOOR IN UNUSED HOLES FOR THE LINEAR ACTUATORS BRACKET.

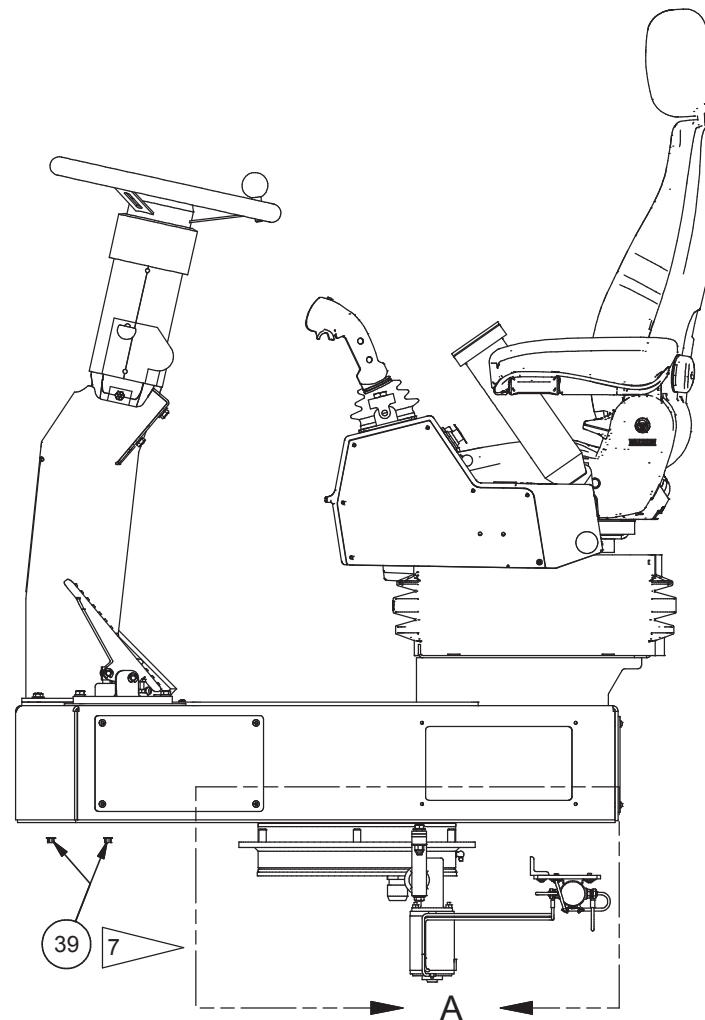
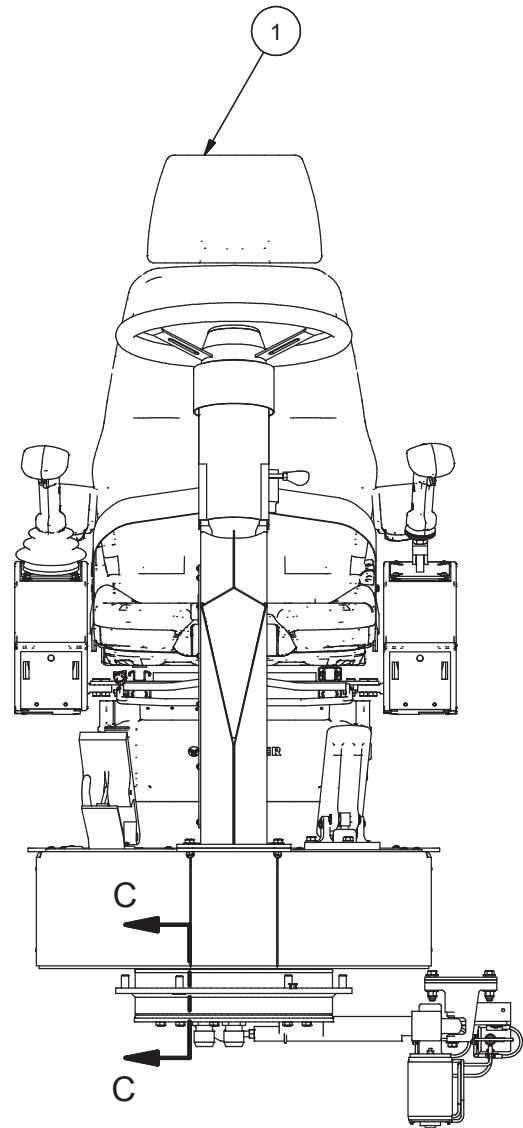

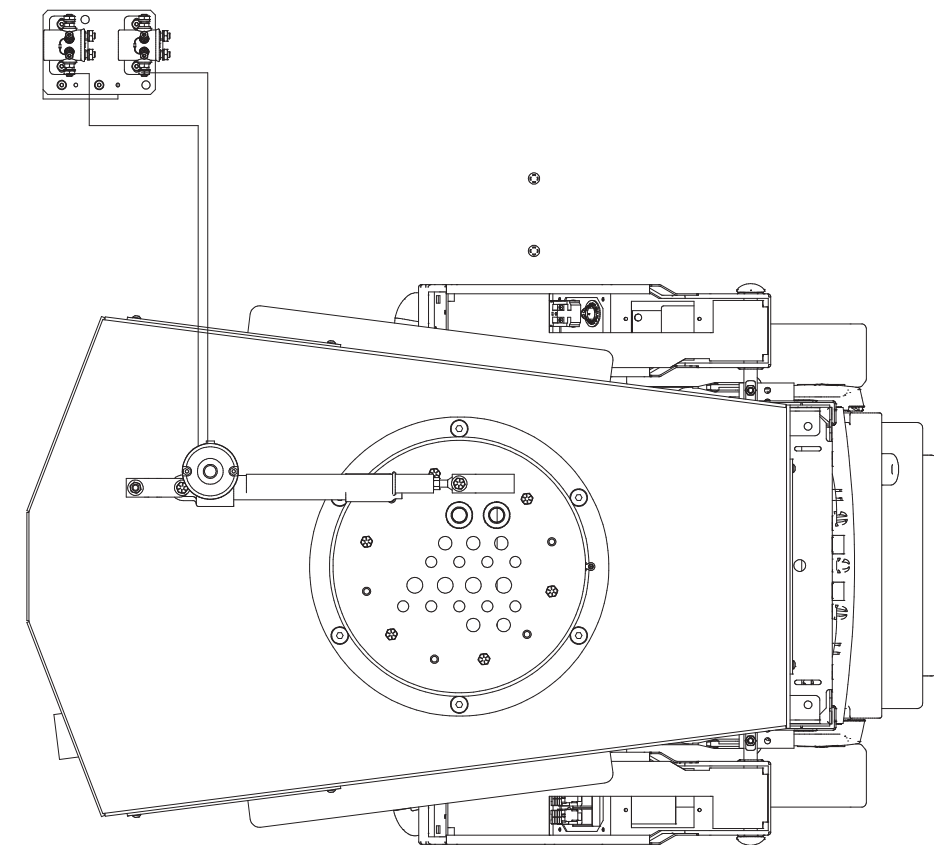
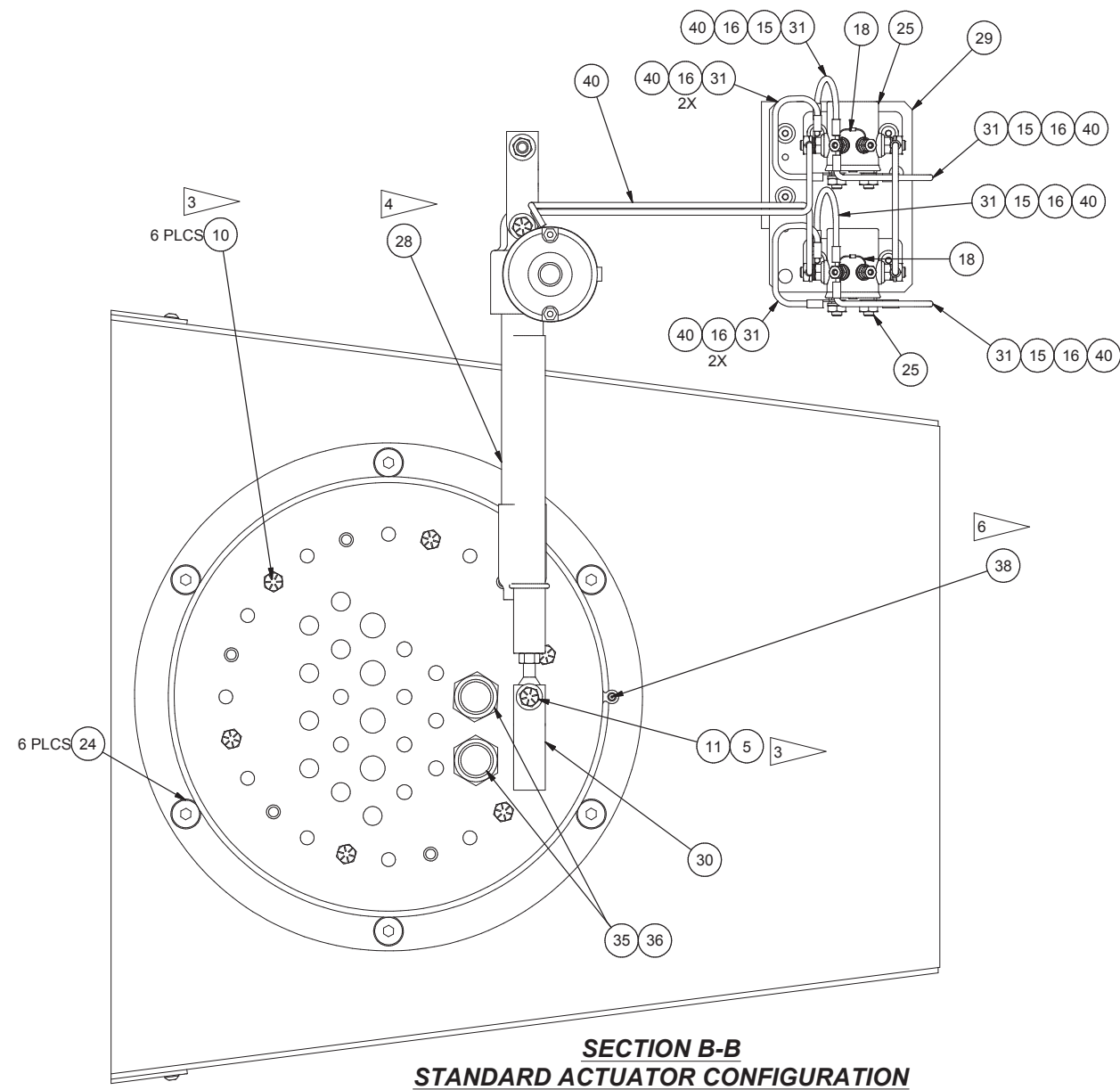
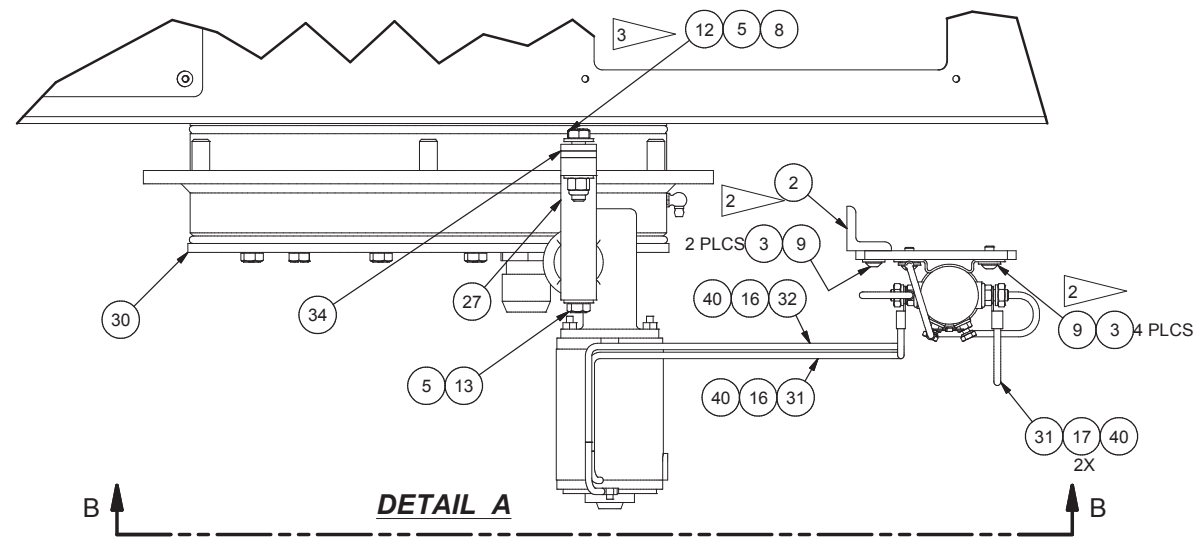

ALTERNATE ACTUATOR CONFIGURATION