

Lights Installation

Lights Installation

Item	Part No.	Qty	Description	Item	Part No.	Qty	Description
	580013		Light Installation				
1	574393	1	. Plate, LH	8	234486	4	. Floodlight
2	574394	1	. Plate, RH	9	221963	4	. Terminal
3	R13811015	6	. Capscrew	10	221964	4	. Terminal
4	232939	6	. Nut, Esna	11	203341	4	. Terminal Ring
5	223428	6	. Flat Washer	12	220949	4	. Mount, Adhesive Back
6	214479	6	. Seal	13	227591	4	. Tie Strap
7	213916	2	. Grommet	14	249167	2	. Connector, Butt
				15	219404	6'	. Wire

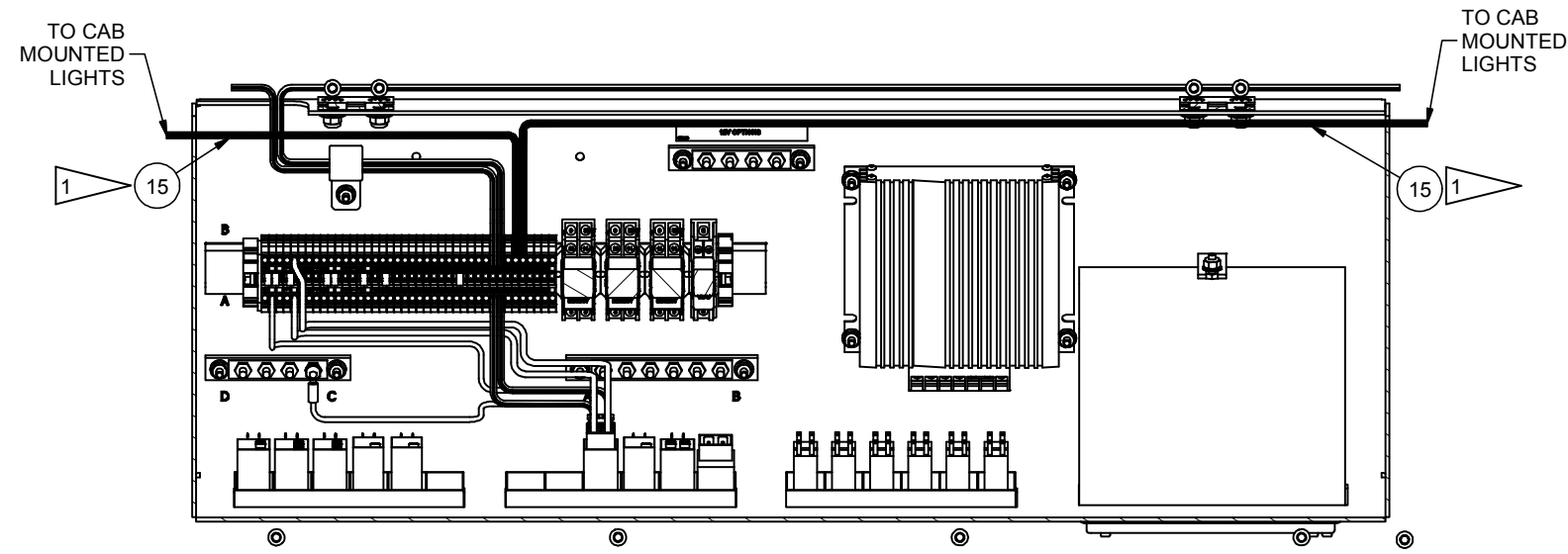
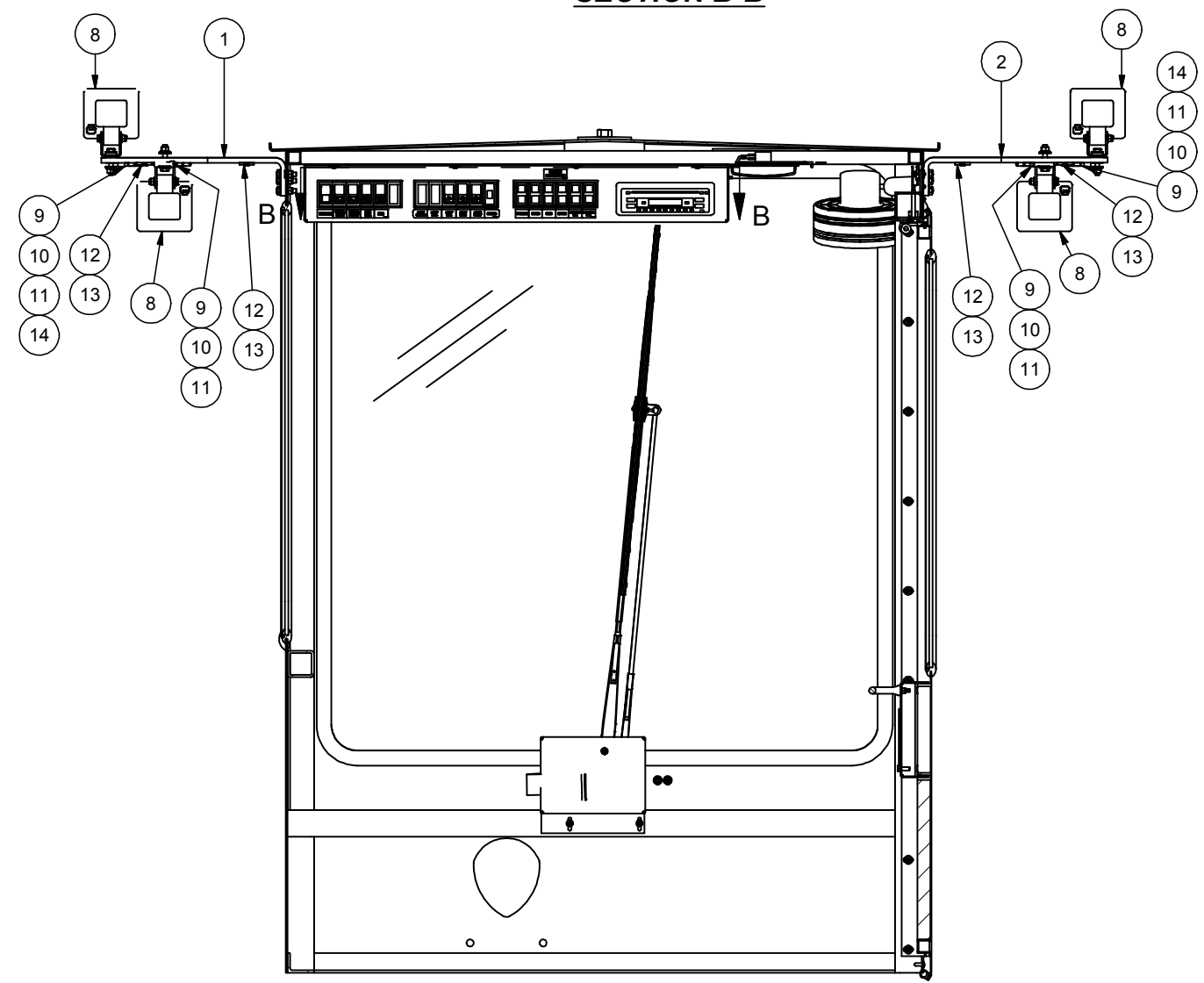

SECTION B-B



SECTION A-A

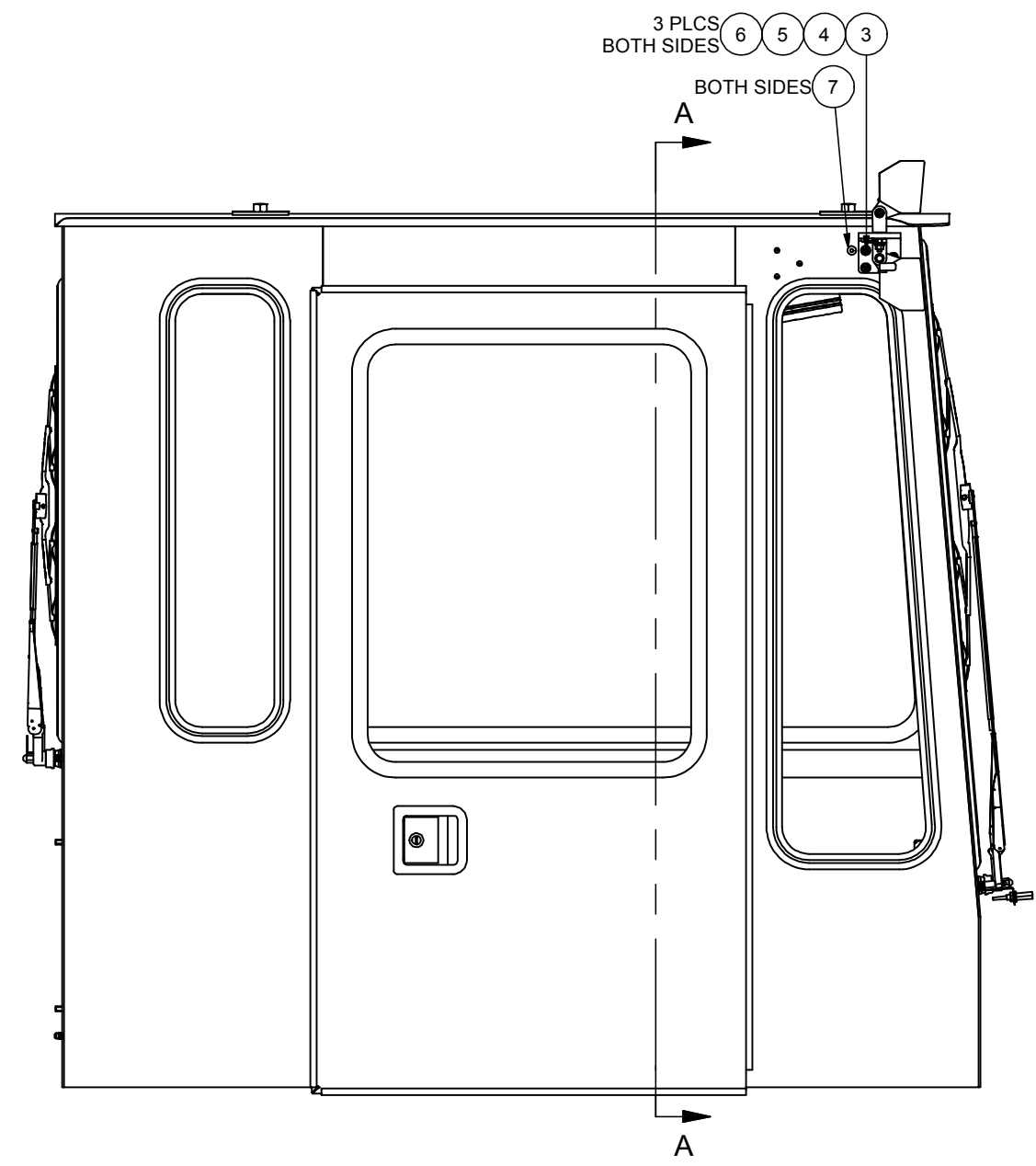

NOTE:
1: REFER TO OVERHEAD CONSOLE ASS'Y. (A SUBASSY. OF THE CAB ASS'Y.) FOR ADJACENT SWITCH AND WIRE CALLOUTS. REFERENCE THE WIRING DIAGRAM ON THE M/S FOR SPECIFIC WIRE LOCATIONS.