

Swivel Box Joint Wear Check

General

The movement between the chassis and the swivel box should be measured annually. Keeping a record of these values will help to determine when the joint has worn excessively. See the table on page 2.

To perform this check, the areas to be measured should be steam cleaned, and the machine should be parked on level ground, with the carriage or bucket lowered. Employ lockout/tagout procedures.

Procedure

1. With the machine parked on level ground, the carriage/bucket lowered, the power turned off, and lockout/tagout procedures employed, set up a dial indicator with a magnetic base on the lower hinge bar, as shown in Figure 1. Zero the indicator in this position.
2. Refer to the jacking locations illustration in your operators manual (section 5), or your service manual (section 10) to determine safe locations to place jacks and jack stands.
3. Using jacks, raise the chassis at the hinge end (rear of chassis for logstackers, front of chassis for dozers) until one of the tires clears the ground. Place jack stands to maintain this chassis position.
4. Record the value of the dial indicator in the table on page 2. This value represents the horizontal movement of the lower hinge bar.
5. Remove the jack stands, and lower the machine.
6. Repeat steps 1-5 for the upper hinge bar.
7. Record the values for the vertical movement for both the upper and lower hinge bars in the same manner. See Figure 2. The dial indicator plunger should set as close to the joint as possible.

Analysis

Review the values recorded in the table. When the movement becomes excessive, contact Allied Systems service department at 503.625.2560.

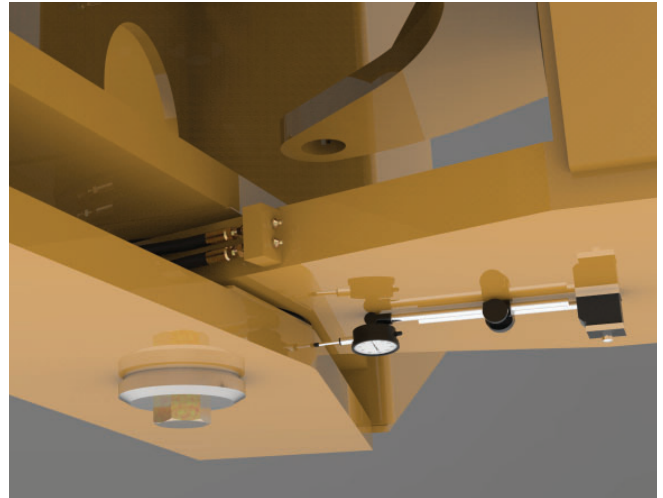

Figure 1 Horizontal Wear Check

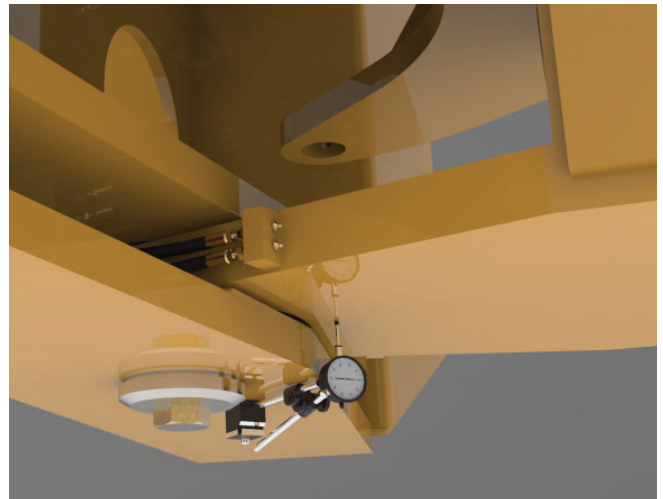

Figure 2 Vertical Wear Check

	Horizontal Movement		Vertical Movement	
	Lower Hinge Bar	Upper Hinge Bar	Lower Hinge Bar	Upper Hinge Bar
Factory Measurement	0.011"	0.008"	0.070"	0.037"
Year 1				
Year 2				
Year 3				
Year 4				
Year 5				
Year 6				
Year 7				
Year 8				
Year 9				
Year 10				
Year 11				
Year 12				
Year 13				
Year 14				
Year 15				
Year 16				
Year 17				
Year 18				
Year 19				
Year 20				
Year 21				
Year 22				
Year 23				
Year 24				
Year 25				
Year 26				
Year 27				
Year 28				
Year 29				
Year 30				
Year 31				
Year 32				
Year 33				
Year 34				
Year 35				
Year 36				
Year 37				
Year 38				