

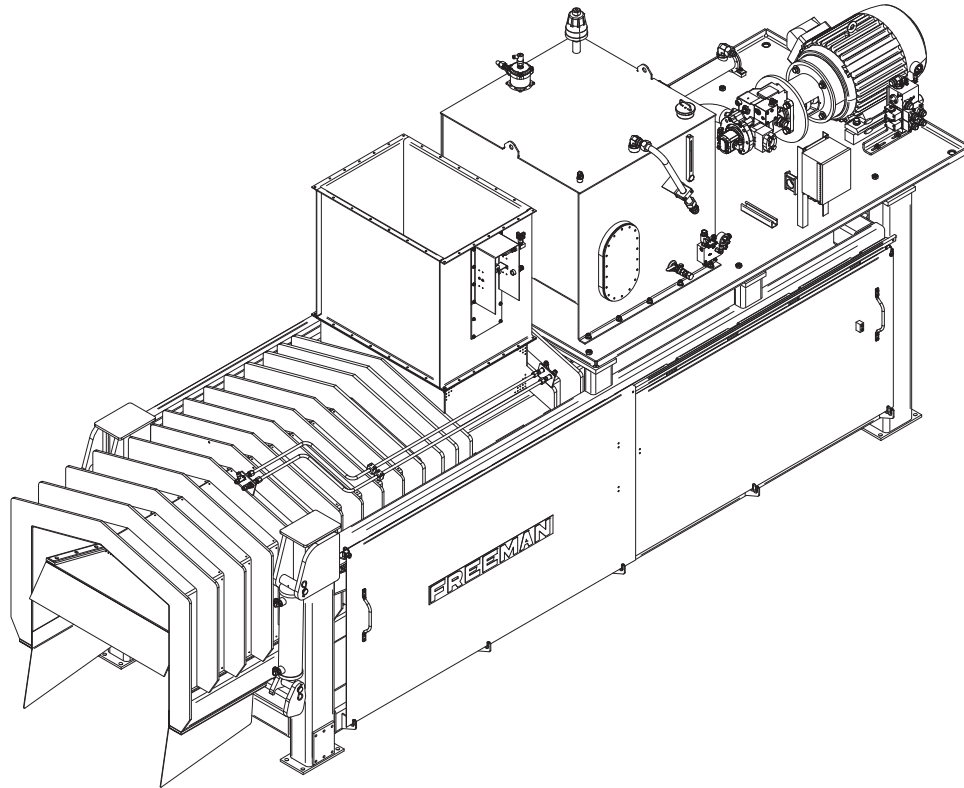

Suggested Spares Guide



WE-5 Water Extractor

89-060

For Serial Number ASC-0WE5-506

A Product of

Allied Systems
COMPANY

Sherwood, Oregon USA

Rev: 7-2015

Part Number	Description	Qty On Extractor	Order Qty
Section 1 - Mechanical			
224960	Motor Coupler, Half	1	
237526	Motor Coupling Insert	1	
253669	Pump Coupler	1	
251917	Lever, Plunger	2	
901645	Plunger Cylinder Pin, Base End	2	
901646	Plunger Cylinder Pin, Plunger End	2	
PLG0021900	Plunger Top Wear Slide	2	
PLG0021920	Plunger Bottom Wear Slide	2	
901027	Plunger LH Wiper	1	
901028	Plunger RH Wiper	1	
901031	Plunger LH Top Wiper	1	
901032	Plunger RH Top Wiper	1	
901056	Plunger Bottom Wiper	1	
RAL0021932	Restriction Rail Wiper UMHW, Long	2	
RAL0021934	Restriction Rail Wiper UMHW, Short	2	
901230	Restriction Rail Pivot Bushing, Rail Side	2	
904030	Restriction Rail Pivot Bushing, Frame Side	4	
WND0024498	In-Feed Window	1	
VLV0026113	Sensor Window Cleaner Tip	1	
Section 2 - Hydraulic			
253672	Hydraulic Pump	1	
906694	Pump, Recirculation	1	
255121	Manifold, Restrictor Control	1	
253979	. Valve, Proportional Relief, Restrictor	1	
2504253	.. Seal Kit For Valve 253979	1	
256264	. Valve, Cartridge, Restrictor	1	
254396	.. Seal Kit For Valve 256264	1	
256021	. Valve, Relief, Restrictor	1	
906737	.. Seal Kit For Valve 256021	1	
255204	Valve, Directional, Plunger	1	
250838	. Seal Kit (Inlet) For Valve 255204	1	
250839	. Seal Kit (Section) For Valve 255204	1	
254535	Pressure Transducer, Plunger Manifold	1	
231135	Pressure Guage, 5000 psi, Plunger Manifold	1	
214203	Pressure Guage, 3000 psi, Restrictor Manifold	1	
255996	Hydraulic Oil Filter Element	1	
256179	Breather Element, Hydraulic Tank	1	
901156	Plunger Cylinder	1	

Part Number	Description	Qty On Extractor	Order Qty
Section 2 - Hydraulic (Cont...)			
901363	. Seal And Packing Kit, Plunger Cyl	1	
902345	Restriction Cylinder Assy	2	
257369	. Seal Kit - Restriction Cylinder	1	
Section 3 - Electrical			
256203	Operator Switch, 2 Pos.	3	
256016	2 Amp Fuse	4	
243609	3 Amp Fuse	1	
243577	5 Amp Fuse	2	
256192	7 Amp Fuse	1	
246933	10 Amp Fuse	2	
230818	Light Bulb, Indicator Lamp, Control Panel, 24V	3	
120MB	Light Bulb, Indicator Lamp, Control Panel, 120V (System Ctrl)	1	
244112	Proximity Switch, Plunger	3	
254163	Proximity Sensor, Infeed Chute	1	
256018	DPDT 120VAC RELAY	1	
256020	Relay DC24	1	
256130	Control Valve Coil	2	
256200	Potentiometer 5W, 10K OHM	5	
SWI0059037	Switch, Float Level	1	
253673	Switch, Temp	1	
253671	Motor 75 HP	1	
906859	Control Module, Programmed	1	

Part Number	Description	Qty On Extractor	Order Qty
Section 4 - Misc Parts/ Tools			
588466	Socket Set, 3/8" Drive, 3/8" - 7/8" STD/Deep 22 Piece		
588467	Socket Set, 1/2" Drive, 3/8" - 1-1/4" STD/Deep 30 Piece		
588468	Socket Set, 3/4" Drive, 7/8" - 2-3/8" STD 29 Piece		
588469	Combination Wrench Set, 5/16" - 2-1/2" 31 Piece		
588528	Combination Wrench Set, 7mm - 24mm, 18 Piece		
588527	Hex Key Set, 1/4" - 5/8", 18 PC		
906600	Kit, Digital Pressure Gauge W/Female QD, -14.5 to +250 psi		

Notes:

* In the "Qty On Extractor" column, indicates that part is used in more than one location. Qty shown is for the listed location only.

- - - - - Indicates that part number was not available at time of publication.

One dot preceding the description indicates that the item is a component part of the previously listed item or assembly with no dot. Example below, the "Rubber Boot Seal" is included in the "Switch Assembly."

Switch

. Rubber Boot Seal

Please include your extractor's serial number when ordering parts.

Diagnostic Tools

Order from Allied Systems
Service Parts Department
503-625-2560.

906601
Kit, Digital Pressure Gauge
W/Female QD Connector
0 to 8700 PSI

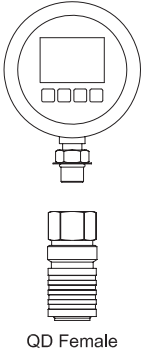

QD Female

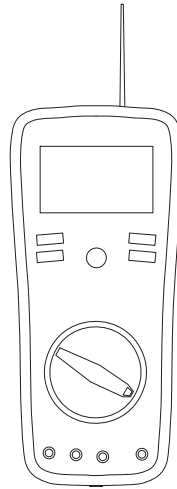

69778
Multi-Meter, 12 Function
AC/DC Voltage & Current, Resistance,
Capacitance, Frequency, Type K & IR
Temperature, Diode/Continuity, Duty Cycle
Non-Contact InfraRed Thermometer
CAT III Test Leads
Type K Bead Wire Temp Probe

QD Male

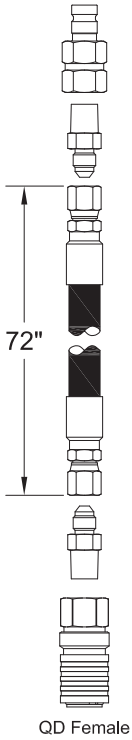

72"

QD Female

69782
Kit, Hose Assembly, W/QD Both Ends



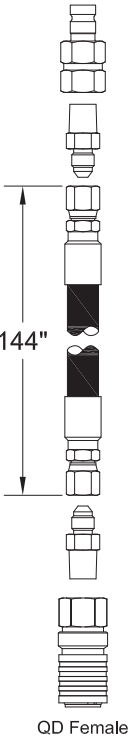



QD Male



144"

QD Female

70381
Kit, Hose Assembly, W/QD Both Ends

QD Male	QD Male
	
1/8 NPT Male	1/8 NPT Female
R14038	R14045
QD Male	QD Male
	
#6 JIC Female	#8 JIC Female
236625	253326
QD Male	QD Male
	
1/4 NPT Female	#4 JIC Female
228040	R330325
QD Male	QD Male
#4 SAE Male connector" data-bbox="770 855 795 895"/>	
#4 SAE Male	#6 SAE Male
R14040	R14082



To find a dealer in your area,
Call: 503-625-2560,
Fax: 503-625-7269, or

Visit our website: <http://www.alliedsystems.com>



89-060 07/2015
Printed in USA